

---

# Product Specification

03/2019

---

**Product** TFT LCD Display

**Mode**

**Abbreviation** C14-BF

---

**Client**

**Customer**

**audit**

---

**Onlineshop: [www.atmparts.eu](http://www.atmparts.eu)**

---

## 1. Product Name

- ✧ TFT LCD display
- ✧ Model : C14

## 2. Suppliers

## 3. Electrical Parameters

- ✧ 3.2inch IPS screen
- ✧ 24V/36V/48V battery supply
- ✧ Rated operating current : 40mA
- ✧ Max operating current : 100mA (36V battery, with USB equipment changed)
- ✧ USB changing port : 5V 500mA
- ✧ Off leakage current < 1uA
- ✧ Max output current to controller : 100mA
- ✧ Operating temperature : -20~70°C, Storage temperature : -30~80°C

## 4. Dimensions & Material

- ✧ Product shell is ABS, transparent window is made with high strength Acrylic.
- ✧ Dimensions : host/L92mm\*W60mm\*H14mm



---

## 5. Features

- ✧ Suitable for low temperature, Max -20°C.
- ✧ High-contrast 3.2inch IPS colorful matrix screen.
- ✧ Ergonomic external button design, easy to operate.
- ✧ **Speed display** : AVG SPEED, MAX SPEED, SPEED(Real-time).
- ✧ **Kilometer / Mile** : Can be set according to customers' habits.
- ✧ **Smart battery indicator** : Provide a reliable battery indicator.
- ✧ **9-level Assist** : 3-level/5-level/9-level optional.
- ✧ **Mileage indicator** : Odometer/Trip distance/ Clock/ Riding time.
- ✧ **Power/Current indicator** : real time power indicator, digital or analog or **Current**.
- ✧ **Error code indicator**.
- ✧ **Software upgraded** : Software can be upgraded through UART.
- ✧ **USB charging port** : 5V/500mA

## 6. TFT screen instructions

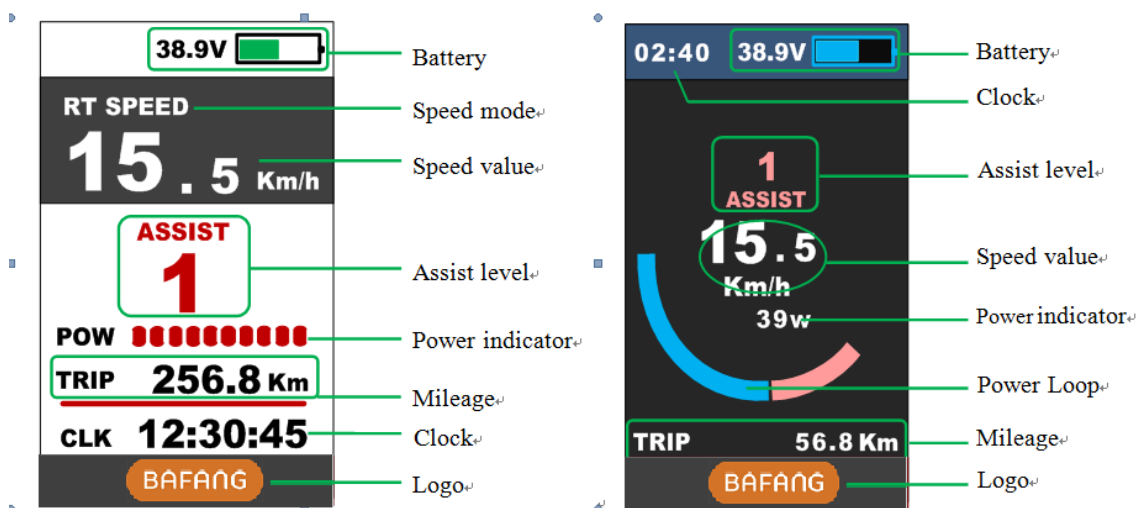

## 7. Functional Description

---

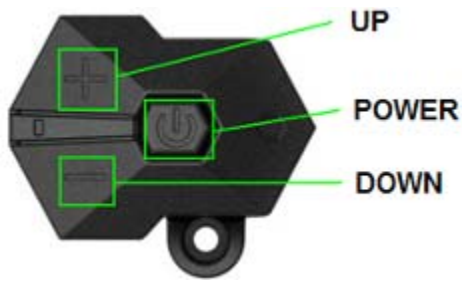

### 7.1 Power On/Off

Press and hold **Power** button for 1 second can turn on/off the display. The Display can automatically shut down when there is no operate & ride for X minutes (X could be 0~9) .

\*If the display has been set password power on, you need to input the right password before start.

### 7.2 Assist level operating

Short press **UP/DOWN** button can change the assist level. Top assist level is 9, 0 for neutral. Level quantities can be adjusted according to the customer requirements.

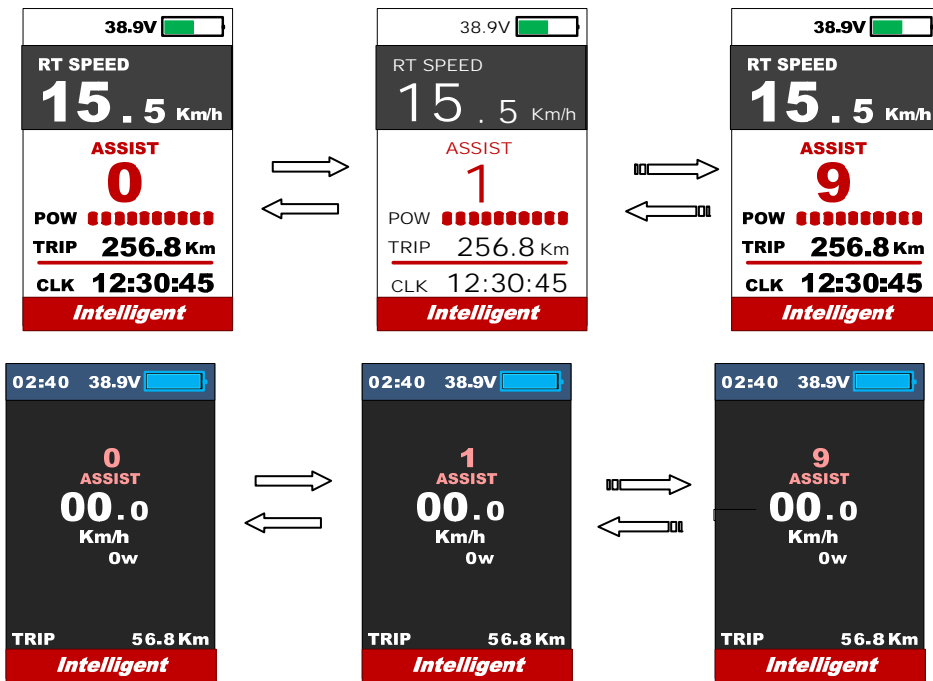

### 7.3 Speed & Mileage mode switch

Short press **POWER** button can change the speed and mileage mode, AVG SPEED->MAX SPEED->RT SPEED->ODO->**RANGE**->TIME->TRIP.

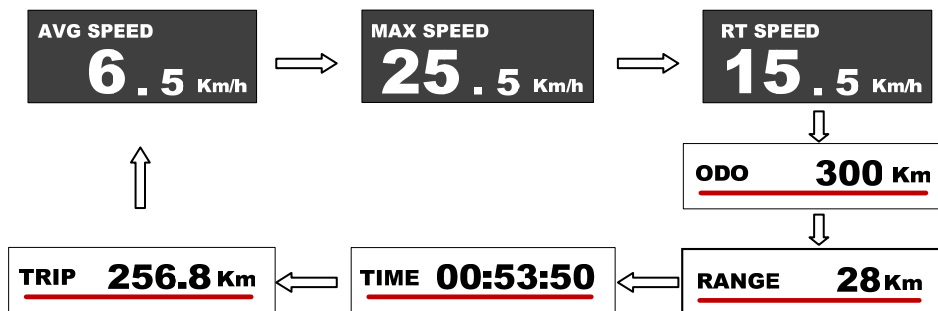

\*Range need smart BMS support.

\*\*If there is no operation for 5 seconds, display will return Speed (Real-Time) display automatically.

### 7.4 Headlight/backlight On/Off

Press and hold **UP** button for 1 second can turn on/off the headlight, and the scree will switch to the corresponding mode.

\*The motor does not work when the battery voltage is low, Display still can keep the headlight on for a while when E-bike is in riding.

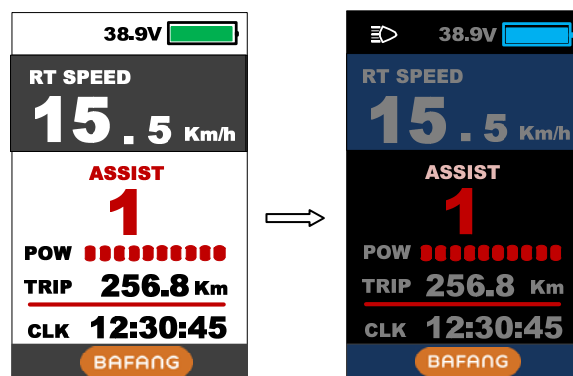

Daytime mode

night mode

### 7.5 Walking mode (6km)

Press and hold **DOWN** button for 2 second can get into walking mode, out of the mode

when release the button.

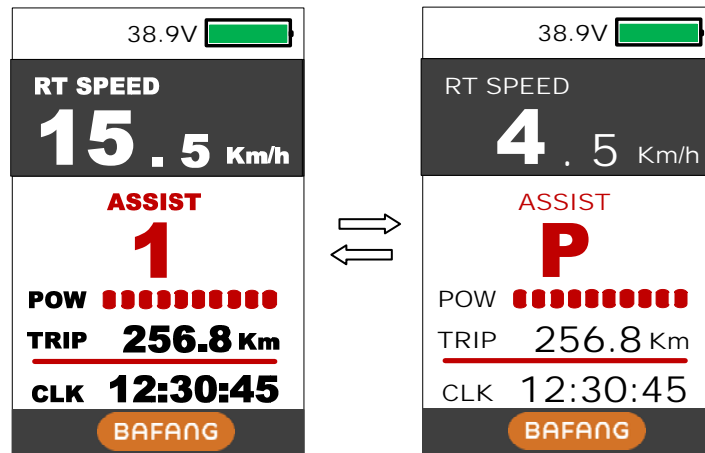

\* This feature needs to be supported by controller.

## 7.6 Data cleanup

Press and hold **UP** & **DOWN** buttons together for 1 second can reset several temporary data, temporary data include **AVG Speed / MAX Speed / Trip / Time**.

\* These temporary data can't be erased by power off.

## 8. Parameter setting

Double press **POWER** button (press interval less than 0.3 second) can get into setting menus, press **UP/DOWN** buttons to change the parameter setting, press **POWER** button can switch to next item. Double press **POWER** button will exit from menu.

\* Display will automatically quit menu when there is no operation for 30 seconds.

\* For safety reasons, display can't get into MENU when riding.

\* Display will quit MENU when start riding.

The order of parameters are as follow.

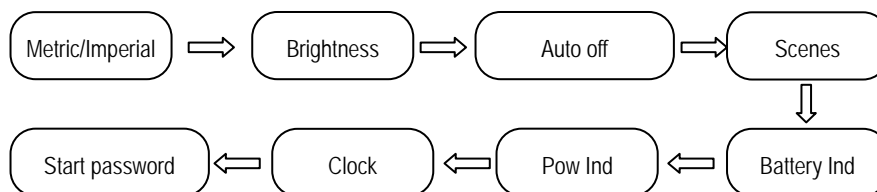

**8.1 System** : Press Up / Down button to switch between Metric / Imperial.

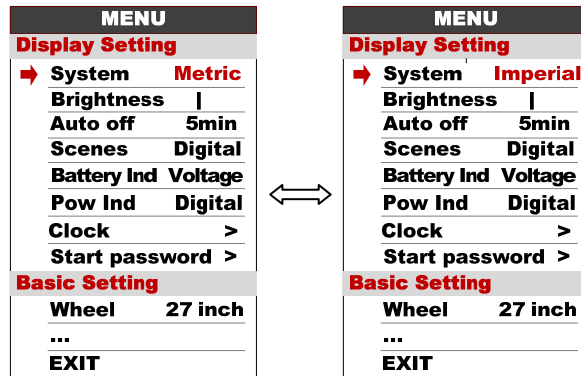

**8.2 Brightness** : Press Up / Down button to change the brightness of the backlight, | is darkness, ||||| is brightness, default value is |.

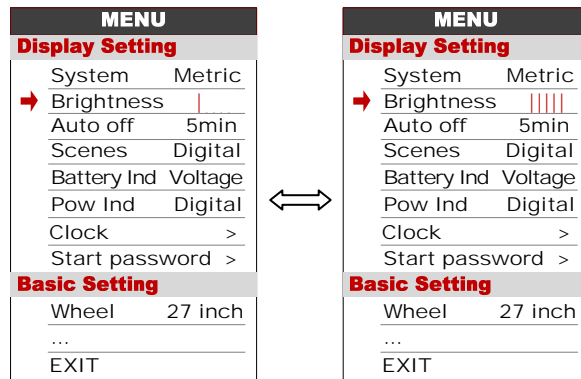

**8.3 Auto off** : Press UP/DOWN button to change the auto power off time, from 1 to 9 or OFF, the number represent time (minutes) to shutdown, default value is 5 minutes.

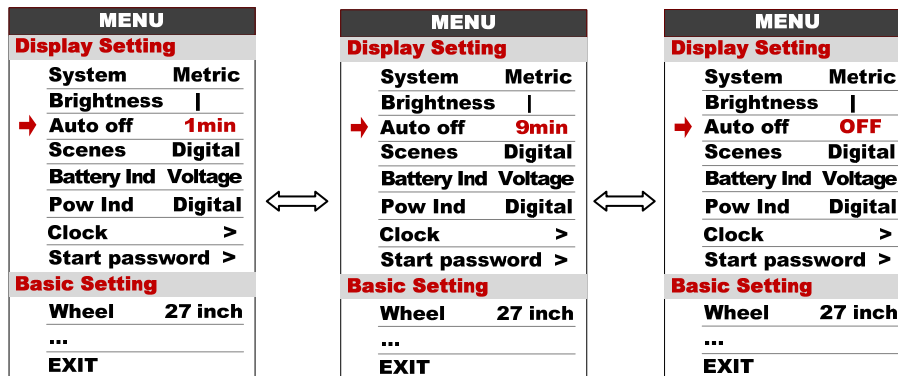

**8.4 Scenes** : Press UP/DOWN button to change the scenes, Digital / Analog.

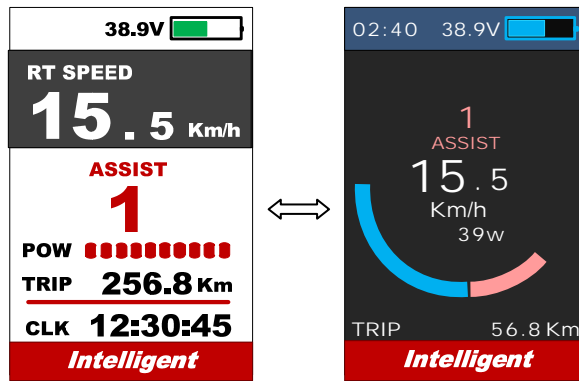
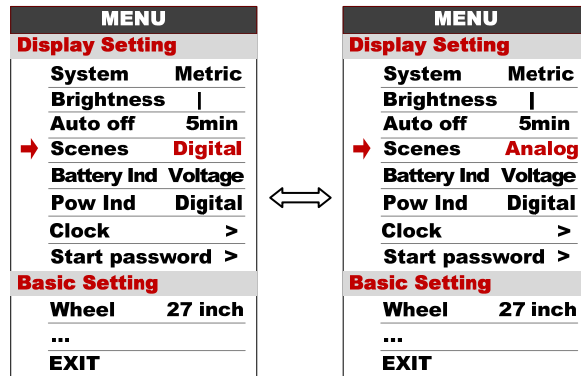

**8.5 Battery Ind** : Press UP/DOWN button to change the battery indicator, Voltage / Percentage / OFF.

\*Accurate percentage needs communication with battery.

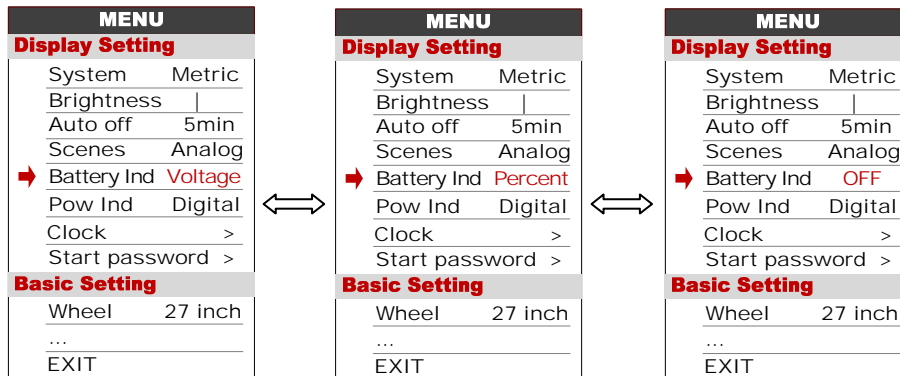



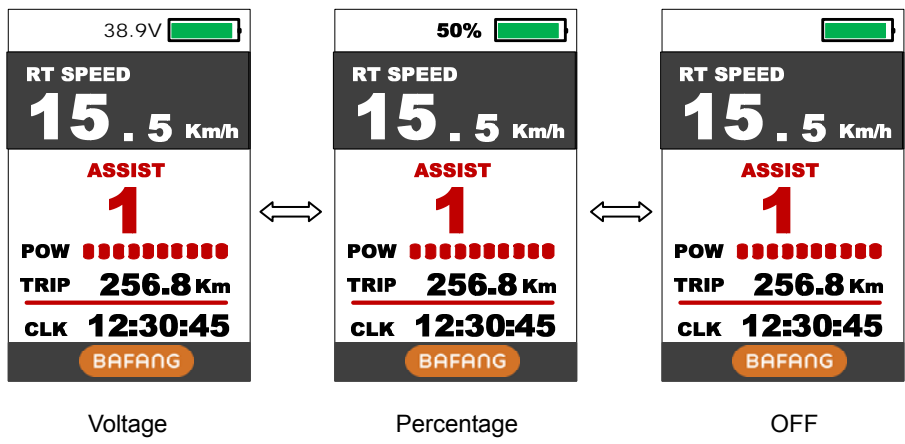

**8.6 Pow Ind :** Press UP/DOWN button to change the Power indicator, Analog / Digital/Current.

\* This data represent power output of the battery (not motor).

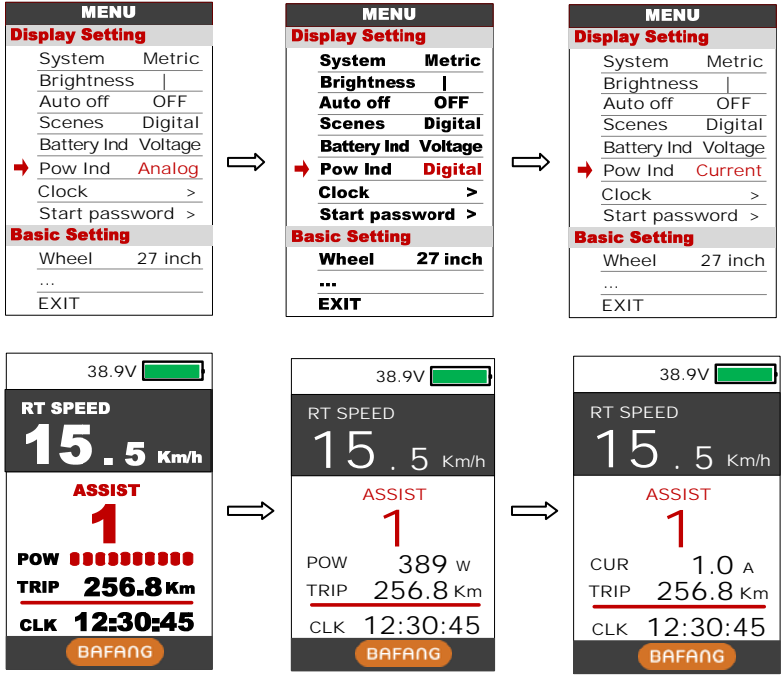

**8.7 Clock :** Clock setting, press POWER button get into the clock setting menu, press UP/DOWN button to set Year/Month/Day/Hour/Min/Sec.

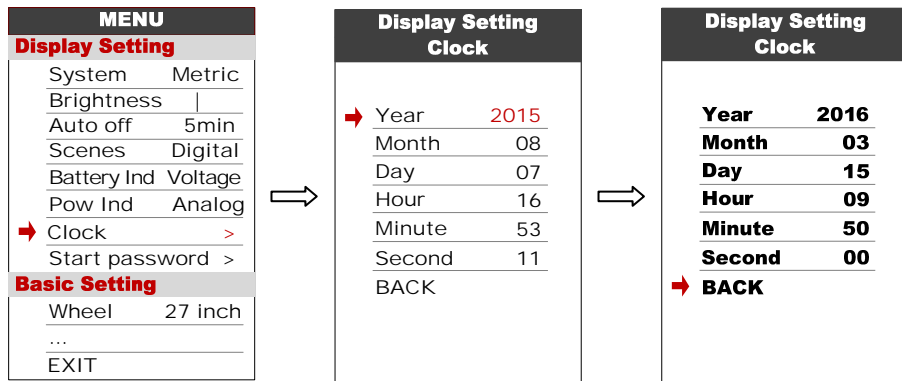

**8.8 Start password :** Press POWER button get into the password setting menu. If you had set Start input ON, you must input right password before power on, password is accorded to your setting.

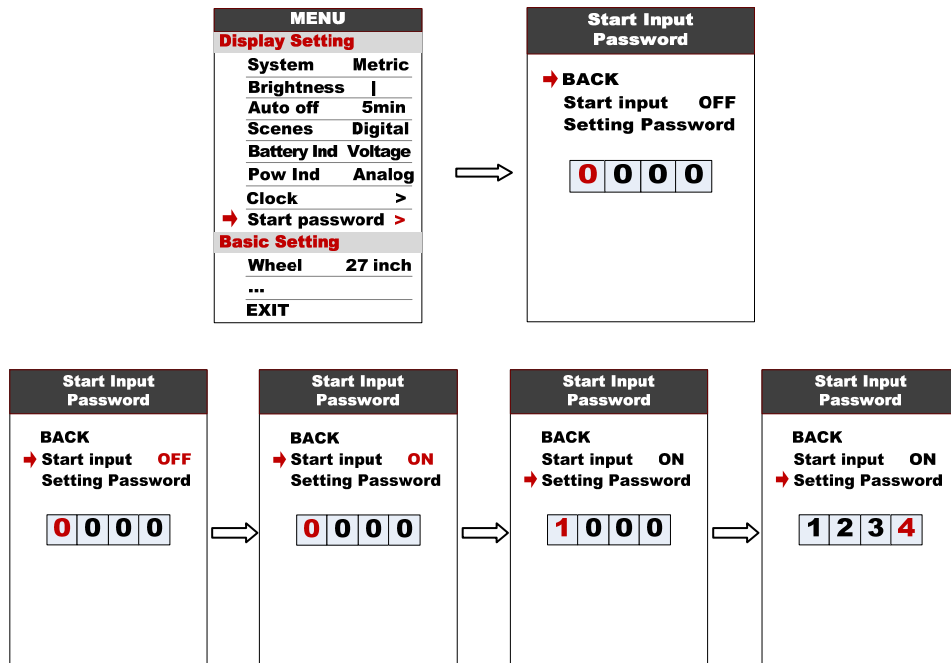

You need to input the right password before start with 30 seconds, display will power off automatically if the password was wrong.

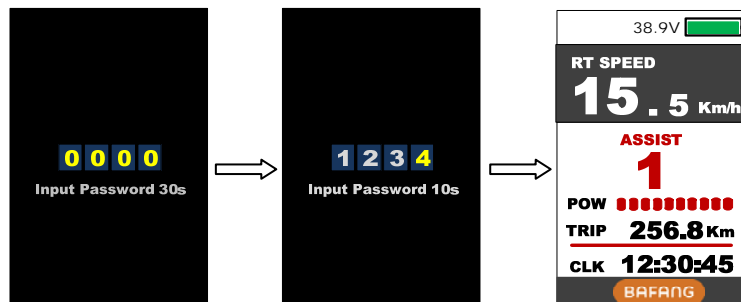

**Basic Setting**

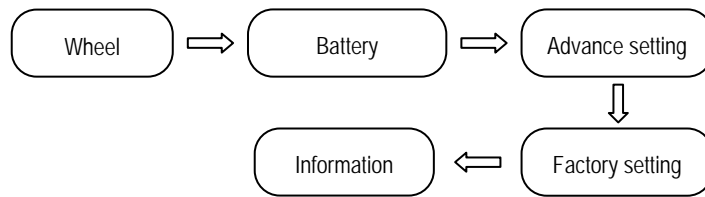

\*Press DOWN button to move the red arrow to **Wheel**, press POWER button can show all items of the Basic Setting.

**8.9 Wheel** : Press UP/DOWN can change the wheel setting, optional wheel diameter is 16/18/20/22/24/26/27/27.5/28/29/30/31 inch, 51cm~255cm represent wheel circumference (this needs controller support).

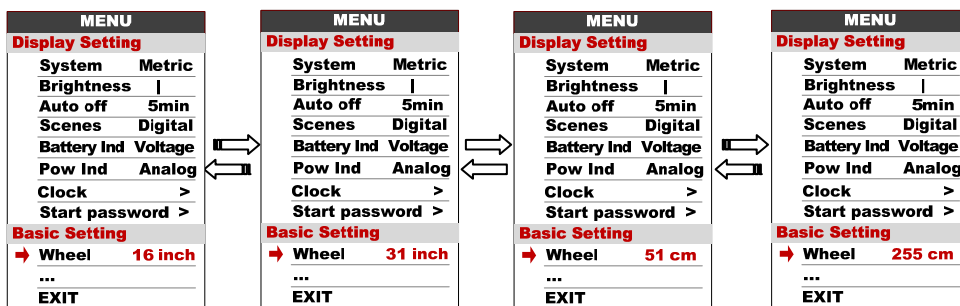

**8.10 Battery** : This option is invalid for Bafang systems. Press UP/DOWN will change battery voltage setting, optional value is 24V/36V/48V/UBE, UBE means user define value.

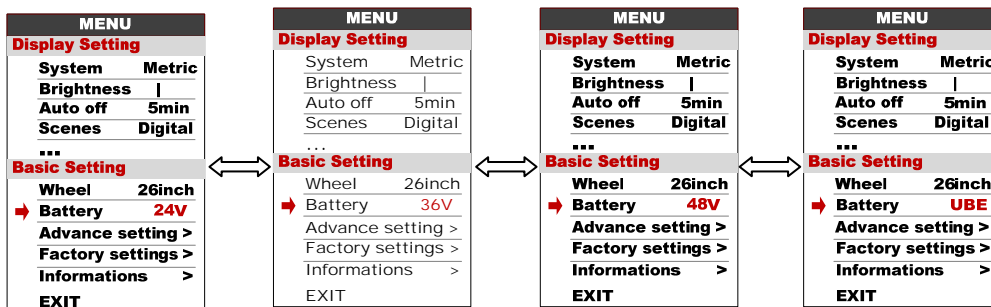

**8.11 Advance setting** : Press POWER button can get into the advance setting menu, default password is '1919'.

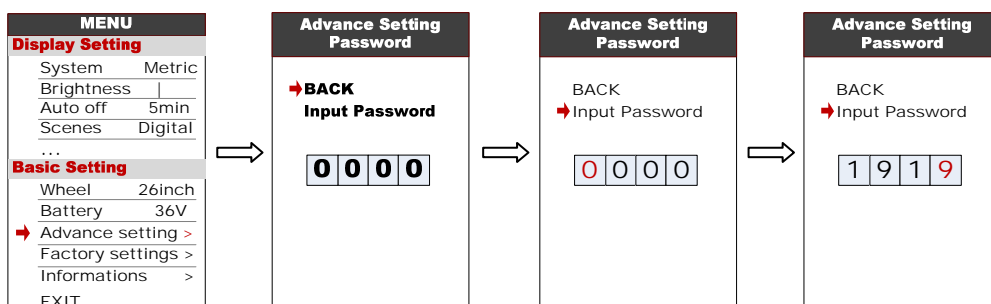

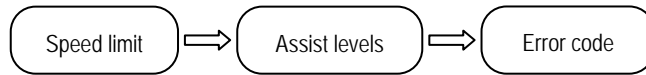

**8.12 Speed limit** : Press UP/DOWN will change speed limit, range 10km/h~45km/h.  
Default value is 25km/h.

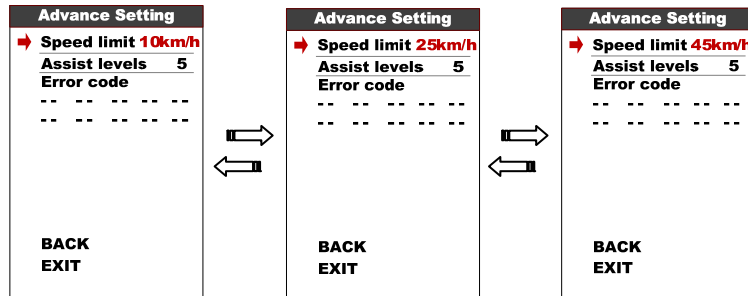

\*Speed limit and current limit are restricted by controller and motor.

**8.13 Assist levels** : This parameter can customize assist levels, options are 3/5/9/UBE, UBE represent factory default settings.

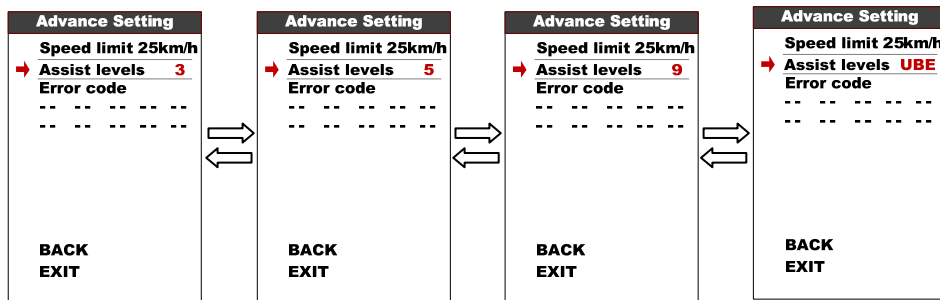

**8.14 Error code** : Display the last 10 times error code.

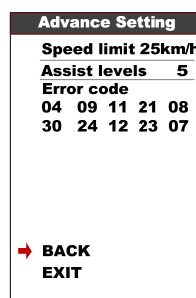

**8.15 Factory setting** : Press POWER button enter Restore Factory settings item, set YES will restore all parameter to factory settings.

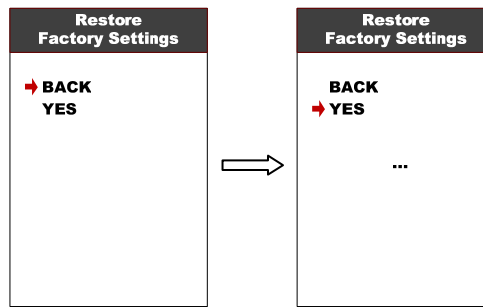

8.16 **Information** : Show information of the E-bike.

Information	
<b>Speed</b>	
AVG	15.4 Km/h
Max	32.4 Km/h
<hr/>	
<b>Mileage</b>	
Trip	9999.9 Km
ODO	99999.9 Km
Range	59.9 Km
→ BACK Product Infor Battery Infor	

8.17 **Product info** : Get into this item can show hardware version software version...

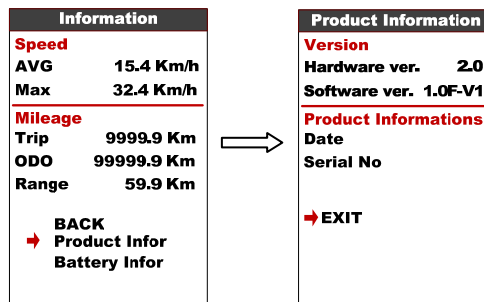

8.18 **Battery info** : Get into this item can show all information of battery, including Voltage, Current, Avg Current, Cycle times, Capacity, Remaining Capacity , Full Charge Capacity , Temperature, Max Tempt, Min Tempt , Relate ChgSta , Absolute ChgSta , Max Uncharge Times , Last Uncharge Times , CorVolt-1.

\*These information needs to be supported by battery communication.

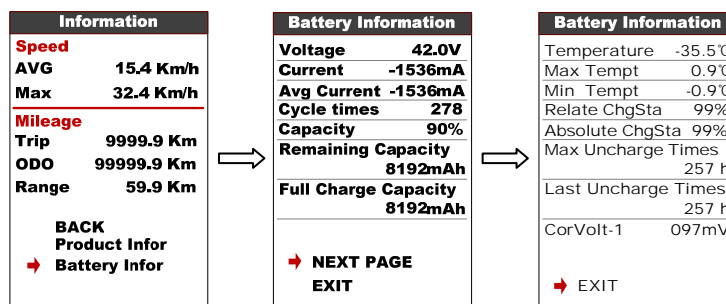

## 9. Error Code define

850C can show warning message,  icon shows on the screen, and show error code at the bottom of the screen, error code from 04H~30H, definition see the table below.

Error Code	Error description	Error display
0x01	Normal	No error
0x03	Brake signal	No error
0x04	Throttle on high position	Display <b>04H</b> on speed position
0x05	Throttle error	Display <b>05H</b> on speed position
0x06	Low voltage protection	Display <b>06H</b> on speed position
0x07	High voltage protection	Display <b>07H</b> on speed position
0x08	Motor's hall sensor error	Display <b>08H</b> on speed position
0x09	Phase line of motor error	Display <b>09H</b> on speed position
0x10	Controller over temperature	Display <b>10H</b> on speed position
0x11	Motor over temperature	Display <b>11H</b> on speed position
0x12	Current sensor error	Display <b>12H</b> on speed position
0x13	Battery's temperature sensor error	Display <b>13H</b> on speed position
0x14	Motor's temperature sensor error	Display <b>14H</b> on speed position
0x15	controller's temperature sensor error	Display <b>15H</b> on speed position
0x21	Speed sensor error	Display <b>21H</b> on speed position
0x22	BMS communication error	Display <b>22H</b> on speed position
0x23	Head light error	Display <b>23H</b> on speed position
0x24	Head light sensor error	Display <b>24H</b> on speed position
0x25	Torque sensor error-Torque	Display <b>25H</b> on speed position
0x26	Torque sensor error-speed	Display <b>26H</b> on speed position
0x30	Communication error	Display <b>30H</b> on speed position

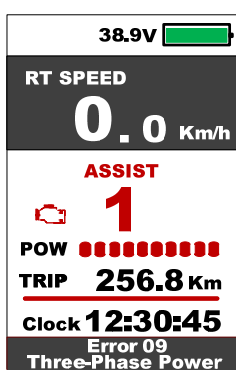

## 10. Assembly instructions

---

Please pay attention to the screw's torque value, damaged caused by excessive torque is not within the scope of the warranty.

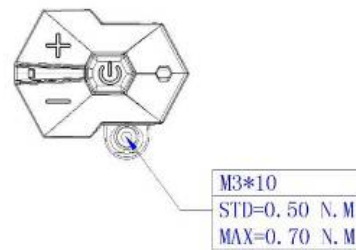
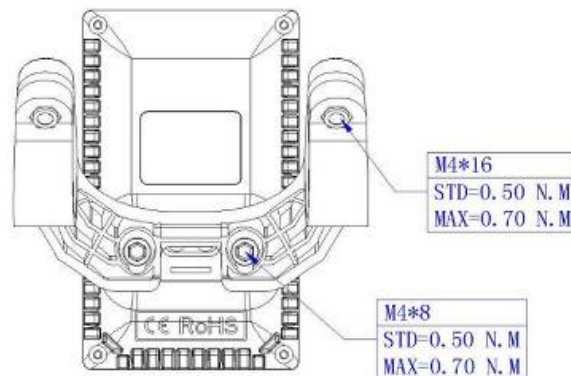

There are 2 directions for the clamp installation, forward or backward.



Clamps suit for 3 size of handlebar, 31.8mm, 25.4mm, 22.2mm, there are transfer rings for 25.4mm and 22.2mm, transfer ring must be assembled with the special directions, pay attention to the green arrow below.



---

## 11. Connector descriptions

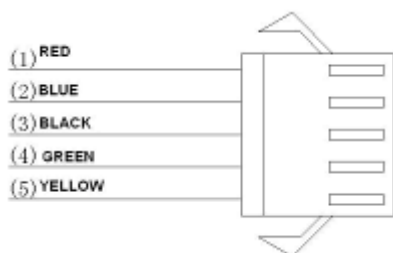

- 1、 Red wire : Anode(24v/36v/48V)
- 2、 Blue wire : Power cord to the controller
- 3、 Black wire : GND
- 4、 Green wire : RxD (controller -> display)
- 5、 Yellow wire : TxD (display -> controller)

## 12. Assist level instructions

Assist level can be customized, the highest level is 9, common used assist level see the table below:

3 level	5 level	9 level	
0		0	No power assist
	1	1	
		2	
1	2	3	
		4	
	3	5	
2		6	
	4	7	
		8	
3	5	9	

## 13. Certification

CE / IP65 (water proof) / ROHS.

---